

Extraction set for hip revisions

Jig-guided system
fitting **optimys** (Mathys)



Handle and extraction bolt

The extraction bolt can be attached on the top or bottom of the handle.

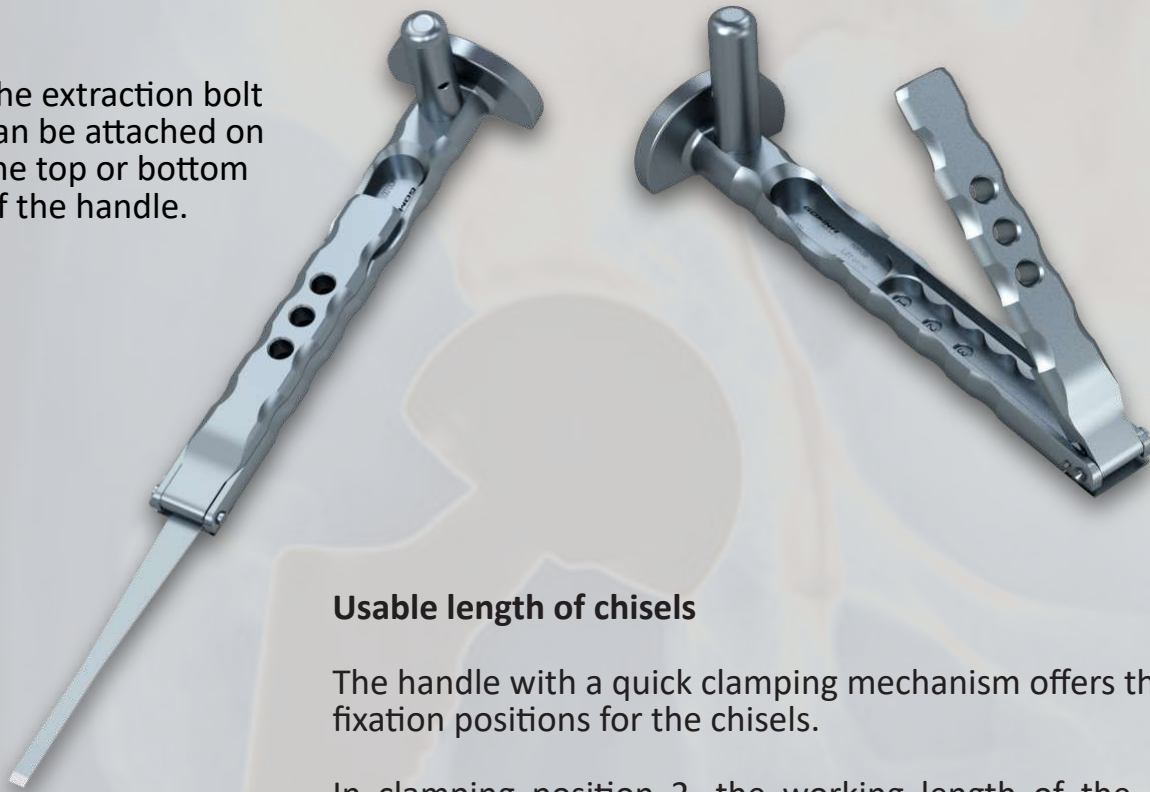

Usable length of chisels

The handle with a quick clamping mechanism offers three fixation positions for the chisels.

In clamping position 2, the working length of the chisel is extended by 15 mm compared to position 1, and by a further 15 mm in position 3. In total, the working length can be extended by 30 mm from position 1 to position 3.

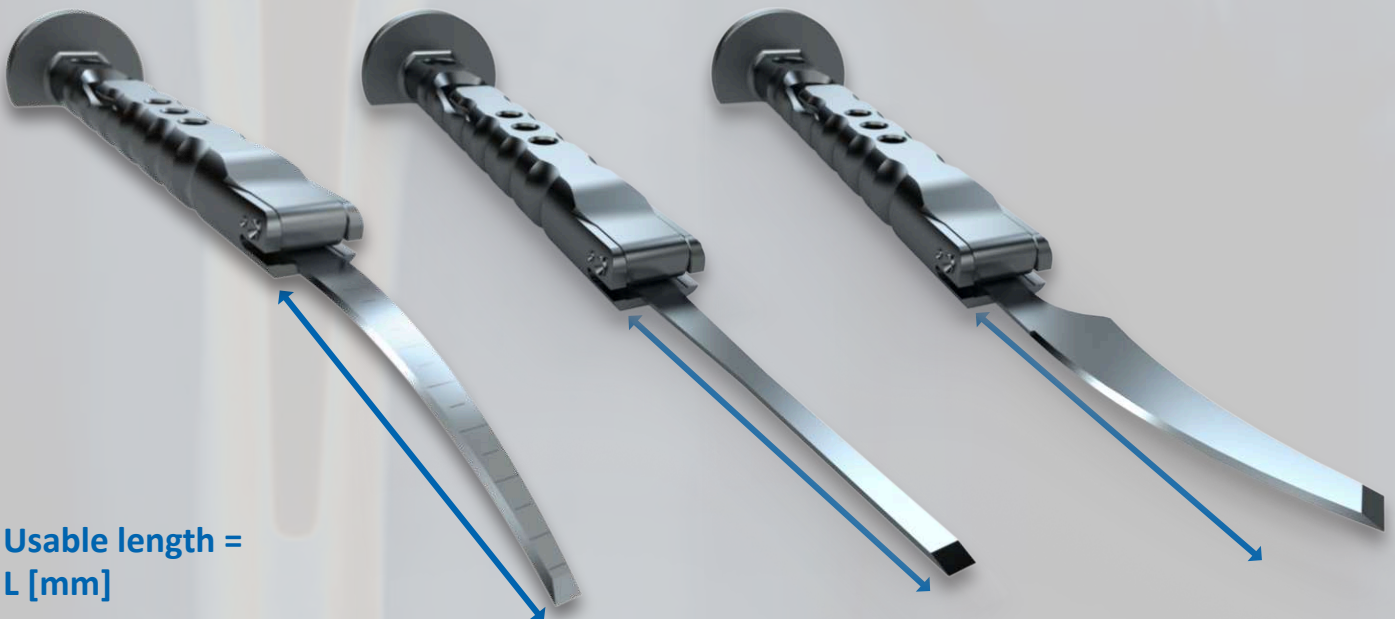

Usable length =
L [mm]

Jig

Guide slots

Guide grooves

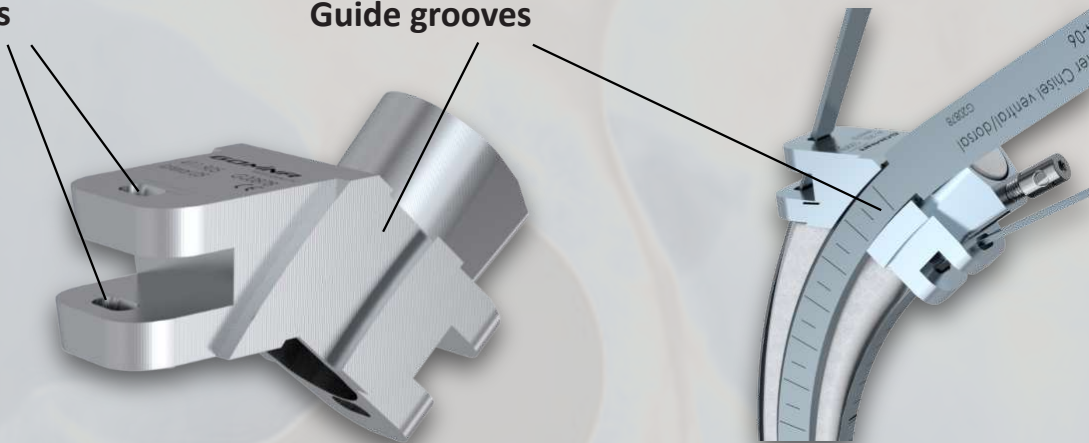

The jig-guided chisels are matched to the guide slots and grooves of the corresponding jigs. The chisels are guided through both guide slots (or grooves) until the cutting edge makes contact with the bone. Then the chisels can be driven in with light hammer strikes.

The jig is positioned on the cone of the stem and attached with the fixation screw.



Overview of chisels with jig

**Note: colors are only for illustrative purpose. The products are not color-coded.*

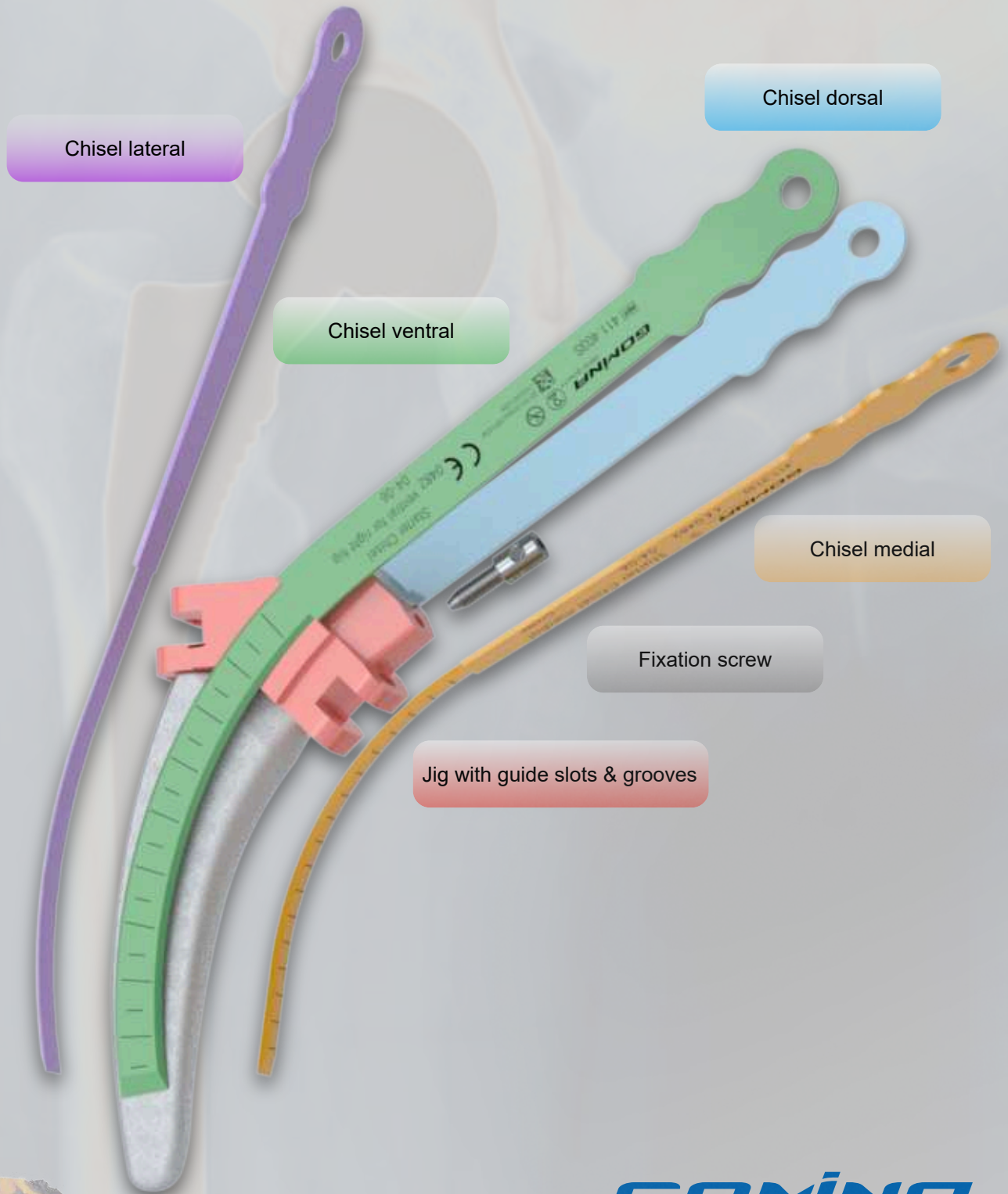

Indicated references by stem size

optimys stem size lat. 1

Reference (sterile)	Article Description	L [mm]	W [mm]	T [mm]
411.201S	Prestarter chisel lateral	64.5	4.8	1.19
411.202S	Prestarter chisel medial	64.7	4.3	1.19
411.210S	Starter chisel lateral 01-03	129.5	4.8	1.19
411.214S	Starter chisel medial 01-03	116.5	4.3	1.19
411.218S	Final chisel lateral 01-03	110.5	4.6	1.19
411.222S	Final chisel medial 01-03	96.5	4.1	1.19
411.409S	Final chisel ventral/dorsal 01-03	118.3	9.0	1.19
411.410S	Final chisel ventral/dorsal 01-03	118.3	9.0	1.19

Ref. (non-sterile)	Article Description
--------------------	---------------------



411.901	Chuck lateral 01
----------------	------------------



400.101	Fixation screw
----------------	----------------



400.106	Allen key
400.111 (with handle)	

Indicated references by stem size

optimys stem size lat. 2

Reference (sterile)	Article Description	L [mm]	W [mm]	T [mm]
411.201S	Prestarter chisel lateral	64.5	4.8	1.19
411.202S	Prestarter chisel medial	64.7	4.3	1.19
411.210S	Starter chisel lateral 01-03	129.5	4.8	1.19
411.214S	Starter chisel medial 01-03	116.5	4.3	1.19
411.218S	Final chisel lateral 01-03	110.5	4.6	1.19
411.222S	Final chisel medial 01-03	96.5	4.1	1.19
411.409S	Final chisel ventral/dorsal 01-03	118.3	9.0	1.19
411.410S	Final chisel ventral/dorsal 01-03	118.3	9.0	1.19

Ref. (non-sterile)	Article Description
--------------------	---------------------



411.902	Chuck lateral 02
----------------	------------------



400.101	Fixation screw
----------------	----------------



400.106	Allen key
400.111 (with handle)	

Indicated references by stem size

optimys stem size lat. 3



Reference (sterile)	Article Description	L [mm]	W [mm]	T [mm]
411.201S	Prestarter chisel lateral	64.5	4.8	1.19
411.202S	Prestarter chisel medial	64.7	4.3	1.19
411.210S	Starter chisel lateral 01-03	129.5	4.8	1.19
411.214S	Starter chisel medial 01-03	116.5	4.3	1.19
411.401S	Starter chisel ventral/dorsal 01-03	125.9	10.0	1.19
411.402S	Starter chisel ventral/dorsal 01-03	125.9	10.0	1.19
411.218S	Final chisel lateral 01-03	110.5	4.6	1.19
411.222S	Final chisel medial 01-03	96.5	4.1	1.19
411.409S	Final chisel ventral/dorsal 01-03	118.3	9.0	1.19
411.410S	Final chisel ventral/dorsal 01-03	118.3	9.0	1.19



Ref. (non-sterile)	Article Description
--------------------	---------------------

411.903	Chuck lateral 03
----------------	------------------

400.101	Fixation screw
----------------	----------------

400.106	Allen key
400.111 (with handle)	



GOMINA
SWISS QUALITY

Indicated references by stem size

optimys stem size lat. 4



Reference (sterile)	Article Description	L [mm]	W [mm]	T [mm]
411.201S	Prestarter chisel lateral	64.5	4.8	1.19
411.202S	Prestarter chisel medial	64.7	4.3	1.19
411.211S	Starter chisel lateral 04-06	134.5	6.0	1.19
411.215S	Starter chisel medial 04-06	123.7	5.6	1.19
411.403S	Starter chisel ventral/dorsal 04-06	130.5	10.0	1.19
411.404S	Starter chisel ventral/dorsal 04-06	130.5	10.0	1.19
411.219S	Final chisel lateral 04-06	116.5	5.8	1.19
411.223S	Final chisel medial 04-06	114.5	5.4	1.19
411.411S	Final chisel ventral/dorsal 04-06	118.4	9.5	1.19
411.412S	Final chisel ventral/dorsal 04-06	118.4	9.5	1.19

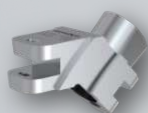

Ref. (non-sterile)	Article Description
--------------------	---------------------

411.904	Chuck lateral 04
----------------	------------------

400.101	Fixation screw
----------------	----------------

400.106	Allen key
400.111 (with handle)	



GOMINA
SWISS QUALITY

Indicated references by stem size

optimys stem size lat. 5



Reference (sterile)	Article Description	L [mm]	W [mm]	T [mm]
411.201S	Prestarter chisel lateral	64.5	4.8	1.19
411.202S	Prestarter chisel medial	64.7	4.3	1.19
411.211S	Starter chisel lateral 04-06	134.5	6.0	1.19
411.215S	Starter chisel medial 04-06	123.7	5.6	1.19
411.403S	Starter chisel ventral/dorsal 04-06	130.5	10.0	1.19
411.404S	Starter chisel ventral/dorsal 04-06	130.5	10.0	1.19
411.219S	Final chisel lateral 04-06	116.5	5.8	1.19
411.223S	Final chisel medial 04-06	114.5	5.4	1.19
411.411S	Final chisel ventral/dorsal 04-06	118.4	9.5	1.19
411.412S	Final chisel ventral/dorsal 04-06	118.4	9.5	1.19



Ref. (non-sterile)	Article Description
--------------------	---------------------

411.905	Chuck lateral 05
----------------	------------------

400.101	Fixation screw
----------------	----------------

400.106	Allen key
400.111 (with handle)	



GOMINA
SWISS QUALITY

Indicated references by stem size

optimys stem size lat. 6

Reference (sterile)	Article Description	L [mm]	W [mm]	T [mm]
411.201S	Prestarter chisel lateral	64.5	4.8	1.19
411.202S	Prestarter chisel medial	64.7	4.3	1.19
411.211S	Starter chisel lateral 04-06	134.5	6.0	1.19
411.215S	Starter chisel medial 04-06	123.7	5.6	1.19
411.403S	Starter chisel ventral/dorsal 04-06	130.5	10.0	1.19
411.404S	Starter chisel ventral/dorsal 04-06	130.5	10.0	1.19
411.219S	Final chisel lateral 04-06	116.5	5.8	1.19
411.223S	Final chisel medial 04-06	114.5	5.4	1.19
411.411S	Final chisel ventral/dorsal 04-06	118.4	9.5	1.19
411.412S	Final chisel ventral/dorsal 04-06	118.4	9.5	1.19

Ref. (non-sterile)	Article Description
--------------------	---------------------

411.906	Chuck lateral 06
----------------	------------------

400.101	Fixation screw
----------------	----------------

400.106	Allen key
400.111 (with handle)	

GOMINA
SWISS QUALITY

Indicated references by stem size

optimys stem size lat. 7

Reference (sterile)	Article Description	L [mm]	W [mm]	T [mm]
411.201S	Prestarter chisel lateral	64.5	4.8	1.19
411.202S	Prestarter chisel medial	64.7	4.3	1.19
411.212S	Starter chisel lateral 07-09	137.5	7.8	1.19
411.216S	Starter chisel medial 07-09	128.7	7.4	1.19
411.405S	Starter chisel ventral/dorsal 07-09	134.0	13.0	1.19
411.406S	Starter chisel ventral/dorsal 07-09	134.0	13.0	1.19
411.220S	Final chisel lateral 07-09	122.5	7.6	1.19
411.224S	Final chisel medial 07-09	114.5	7.2	1.19
411.413S	Final chisel ventral/dorsal 07-09	118.5	12.0	1.19
411.414S	Final chisel ventral/dorsal 07-09	118.5	12.0	1.19

Ref. (non-sterile)	Article Description
--------------------	---------------------

411.907	Chuck lateral 07
----------------	------------------

400.101	Fixation screw
----------------	----------------

400.106	Allen key
400.111 (with handle)	

GOMINA
SWISS QUALITY

Indicated references by stem size

optimys stem size lat. 8



Reference (sterile)	Article Description	L [mm]	W [mm]	T [mm]
411.201S	Prestarter chisel lateral	64.5	4.8	1.19
411.202S	Prestarter chisel medial	64.7	4.3	1.19
411.212S	Starter chisel lateral 07-09	137.5	7.8	1.19
411.216S	Starter chisel medial 07-09	128.7	7.4	1.19
411.405S	Starter chisel ventral/dorsal 07-09	134.0	13.0	1.19
411.406S	Starter chisel ventral/dorsal 07-09	134.0	13.0	1.19
411.220S	Final chisel lateral 07-09	122.5	7.6	1.19
411.224S	Final chisel medial 07-09	114.5	7.2	1.19
411.413S	Final chisel ventral/dorsal 07-09	118.5	12.0	1.19
411.414S	Final chisel ventral/dorsal 07-09	118.5	12.0	1.19



Ref. (non-sterile)	Article Description
--------------------	---------------------

411.908	Chuck lateral 08
----------------	------------------

400.101	Fixation screw
----------------	----------------

400.106	Allen key
400.111 (with handle)	



GOMINA
SWISS QUALITY

Indicated references by stem size

optimys stem size lat. 9

Reference (sterile)	Article Description	L [mm]	W [mm]	T [mm]
411.201S	Prestarter chisel lateral	64.5	4.8	1.19
411.202S	Prestarter chisel medial	64.7	4.3	1.19
411.212S	Starter chisel lateral 07-09	137.5	7.8	1.19
411.216S	Starter chisel medial 07-09	128.7	7.4	1.19
411.405S	Starter chisel ventral/dorsal 07-09	134.0	13.0	1.19
411.406S	Starter chisel ventral/dorsal 07-09	134.0	13.0	1.19
411.220S	Final chisel lateral 07-09	122.5	7.6	1.19
411.224S	Final chisel medial 07-09	114.5	7.2	1.19
411.413S	Final chisel ventral/dorsal 07-09	118.5	12.0	1.19
411.414S	Final chisel ventral/dorsal 07-09	118.5	12.0	1.19

Ref. (non-sterile)	Article Description
--------------------	---------------------

411.909	Chuck lateral 09
----------------	------------------

400.101	Fixation screw
----------------	----------------

400.106	Allen key
400.111 (with handle)	

GOMINA
SWISS QUALITY

Indicated references by stem size

optimys stem size lat. 10

Reference (sterile)	Article Description	L [mm]	W [mm]	T [mm]
411.201S	Prestarter chisel lateral	64.5	4.8	1.19
411.202S	Prestarter chisel medial	64.7	4.3	1.19
411.213S	Starter chisel lateral 10-12	143.5	9.0	1.19
411.217S	Starter chisel medial 10-12	134.7	8.7	1.19
411.407S	Starter chisel ventral/dorsal 10-12	157.4	16.0	1.19
411.408S	Starter chisel ventral/dorsal 10-12	157.4	16.0	1.19
411.221S	Final chisel lateral 10-12	128.5	8.8	1.19
411.225S	Final chisel medial 10-12	119.5	8.5	1.19
411.415S	Final chisel ventral/dorsal 10-12	118.0	15.0	1.19
411.416S	Final chisel ventral/dorsal 10-12	118.0	15.0	1.19

Ref. (non-sterile)	Article Description
--------------------	---------------------

411.910	Chuck lateral 10
----------------	------------------

400.101	Fixation screw
----------------	----------------

400.106	Allen key
400.111 (with handle)	

GOMINA
SWISS QUALITY

Indicated references by stem size

optimys stem size lat. 11

Reference (sterile)	Article Description	L [mm]	W [mm]	T [mm]
411.201S	Prestarter chisel lateral	64.5	4.8	1.19
411.202S	Prestarter chisel medial	64.7	4.3	1.19
411.213S	Starter chisel lateral 10-12	143.5	9.0	1.19
411.217S	Starter chisel medial 10-12	134.7	8.7	1.19
411.407S	Starter chisel ventral/dorsal 10-12	157.4	16.0	1.19
411.408S	Starter chisel ventral/dorsal 10-12	157.4	16.0	1.19
411.221S	Final chisel lateral 10-12	128.5	8.8	1.19
411.225S	Final chisel medial 10-12	119.5	8.5	1.19
411.415S	Final chisel ventral/dorsal 10-12	118.0	15.0	1.19
411.416S	Final chisel ventral/dorsal 10-12	118.0	15.0	1.19

Ref. (non-sterile)	Article Description
--------------------	---------------------

411.911	Chuck lateral 11
----------------	------------------

400.101	Fixation screw
----------------	----------------

400.106	Allen key
400.111 (with handle)	

GOMINA
SWISS QUALITY

Indicated references by stem size

optimys stem size lat. 12

Reference (sterile)	Article Description	L [mm]	W [mm]	T [mm]
411.201S	Prestarter chisel lateral	64.5	4.8	1.19
411.202S	Prestarter chisel medial	64.7	4.3	1.19
411.213S	Starter chisel lateral 10-12	143.5	9.0	1.19
411.217S	Starter chisel medial 10-12	134.7	8.7	1.19
411.407S	Starter chisel ventral/dorsal 10-12	157.4	16.0	1.19
411.408S	Starter chisel ventral/dorsal 10-12	157.4	16.0	1.19
411.221S	Final chisel lateral 10-12	128.5	8.8	1.19
411.225S	Final chisel medial 10-12	119.5	8.5	1.19
411.415S	Final chisel ventral/dorsal 10-12	118.0	15.0	1.19
411.416S	Final chisel ventral/dorsal 10-12	118.0	15.0	1.19

Ref. (non-sterile)	Article Description
--------------------	---------------------

411.912	Chuck lateral 12
----------------	------------------

400.101	Fixation screw
----------------	----------------

400.106	Allen key
400.111 (with handle)	

GOMINA
SWISS QUALITY

Indicated references by stem size

optimys stem size std. 1

Reference (sterile)	Article Description	L [mm]	W [mm]	T [mm]
411.201S	Prestarter chisel lateral	64.5	4.8	1.19
411.202S	Prestarter chisel medial	64.7	4.3	1.19
411.210S	Starter chisel lateral 01-03	129.5	4.8	1.19
411.214S	Starter chisel medial 01-03	116.5	4.3	1.19
411.218S	Final chisel lateral 01-03	110.5	4.6	1.19
411.222S	Final chisel medial 01-03	96.5	4.1	1.19
411.409S	Final chisel ventral/dorsal 01-03	118.3	9.0	1.19
411.410S	Final chisel ventral/dorsal 01-03	118.3	9.0	1.19

Ref. (non-sterile)	Article Description
--------------------	---------------------



411.921	Chuck standard 01
----------------	-------------------



400.101	Fixation screw
----------------	----------------



400.106	Allen key
400.111 (with handle)	

Indicated references by stem size

optimys stem size std. 2

Reference (sterile)	Article Description	L [mm]	W [mm]	T [mm]
411.201S	Prestarter chisel lateral	64.5	4.8	1.19
411.202S	Prestarter chisel medial	64.7	4.3	1.19
411.210S	Starter chisel lateral 01-03	129.5	4.8	1.19
411.214S	Starter chisel medial 01-03	116.5	4.3	1.19
411.218S	Final chisel lateral 01-03	110.5	4.6	1.19
411.222S	Final chisel medial 01-03	96.5	4.1	1.19
411.409S	Final chisel ventral/dorsal 01-03	118.3	9.0	1.19
411.410S	Final chisel ventral/dorsal 01-03	118.3	9.0	1.19

Ref. (non-sterile)	Article Description
--------------------	---------------------

411.922	Chuck standard 02
----------------	-------------------

400.101	Fixation screw
----------------	----------------

400.106	Allen key
400.111 (with handle)	

Indicated references by stem size

optimys stem size std. 3

Reference (sterile)	Article Description	L [mm]	W [mm]	T [mm]
411.201S	Prestarter chisel lateral	64.5	4.8	1.19
411.202S	Prestarter chisel medial	64.7	4.3	1.19
411.210S	Starter chisel lateral 01-03	129.5	4.8	1.19
411.214S	Starter chisel medial 01-03	116.5	4.3	1.19
411.401S	Starter chisel ventral/dorsal 01-03	125.9	10.0	1.19
411.402S	Starter chisel ventral/dorsal 01-03	125.9	10.0	1.19
411.218S	Final chisel lateral 01-03	110.5	4.6	1.19
411.222S	Final chisel medial 01-03	96.5	4.1	1.19
411.409S	Final chisel ventral/dorsal 01-03	118.3	9.0	1.19
411.410S	Final chisel ventral/dorsal 01-03	118.3	9.0	1.19

Ref. (non-sterile)	Article Description
--------------------	---------------------

411.923	Chuck standard 03
----------------	-------------------

400.101	Fixation screw
----------------	----------------

400.106	Allen key
400.111 (with handle)	

GOMINA
SWISS QUALITY

Indicated references by stem size

optimys stem size std. 4

Reference (sterile)	Article Description	L [mm]	W [mm]	T [mm]
411.201S	Prestarter chisel lateral	64.5	4.8	1.19
411.202S	Prestarter chisel medial	64.7	4.3	1.19
411.211S	Starter chisel lateral 04-06	134.5	6.0	1.19
411.215S	Starter chisel medial 04-06	123.7	5.6	1.19
411.403S	Starter chisel ventral/dorsal 04-06	130.5	10.0	1.19
411.404S	Starter chisel ventral/dorsal 04-06	130.5	10.0	1.19
411.219S	Final chisel lateral 04-06	116.5	5.8	1.19
411.223S	Final chisel medial 04-06	114.5	5.4	1.19
411.411S	Final chisel ventral/dorsal 04-06	118.4	9.5	1.19
411.412S	Final chisel ventral/dorsal 04-06	118.4	9.5	1.19

Ref. (non-sterile)	Article Description
--------------------	---------------------

411.924	Chuck standard 04
----------------	-------------------

400.101	Fixation screw
----------------	----------------

400.106	Allen key
400.111 (with handle)	

GOMINA
SWISS QUALITY

Indicated references by stem size

optimys stem size std. 5



Reference (sterile)	Article Description	L [mm]	W [mm]	T [mm]
411.201S	Prestarter chisel lateral	64.5	4.8	1.19
411.202S	Prestarter chisel medial	64.7	4.3	1.19
411.211S	Starter chisel lateral 04-06	134.5	6.0	1.19
411.215S	Starter chisel medial 04-06	123.7	5.6	1.19
411.403S	Starter chisel ventral/dorsal 04-06	130.5	10.0	1.19
411.404S	Starter chisel ventral/dorsal 04-06	130.5	10.0	1.19
411.219S	Final chisel lateral 04-06	116.5	5.8	1.19
411.223S	Final chisel medial 04-06	114.5	5.4	1.19
411.411S	Final chisel ventral/dorsal 04-06	118.4	9.5	1.19
411.412S	Final chisel ventral/dorsal 04-06	118.4	9.5	1.19



Ref. (non-sterile)	Article Description
--------------------	---------------------

411.925	Chuck standard 05
----------------	-------------------

400.101	Fixation screw
----------------	----------------

400.106	Allen key
400.111 (with handle)	



GOMINA
SWISS QUALITY

Indicated references by stem size

optimys stem size std. 6

Reference (sterile)	Article Description	L [mm]	W [mm]	T [mm]
411.201S	Prestarter chisel lateral	64.5	4.8	1.19
411.202S	Prestarter chisel medial	64.7	4.3	1.19
411.211S	Starter chisel lateral 04-06	134.5	6.0	1.19
411.215S	Starter chisel medial 04-06	123.7	5.6	1.19
411.403S	Starter chisel ventral/dorsal 04-06	130.5	10.0	1.19
411.404S	Starter chisel ventral/dorsal 04-06	130.5	10.0	1.19
411.219S	Final chisel lateral 04-06	116.5	5.8	1.19
411.223S	Final chisel medial 04-06	114.5	5.4	1.19
411.411S	Final chisel ventral/dorsal 04-06	118.4	9.5	1.19
411.412S	Final chisel ventral/dorsal 04-06	118.4	9.5	1.19

Ref. (non-sterile)	Article Description
--------------------	---------------------

411.926	Chuck standard 06
----------------	-------------------

400.101	Fixation screw
----------------	----------------

400.106	Allen key
400.111 (with handle)	

GOMINA
SWISS QUALITY

Indicated references by stem size

optimys stem size std. 7

Reference (sterile)	Article Description	L [mm]	W [mm]	T [mm]
411.201S	Prestarter chisel lateral	64.5	4.8	1.19
411.202S	Prestarter chisel medial	64.7	4.3	1.19
411.212S	Starter chisel lateral 07-09	137.5	7.8	1.19
411.216S	Starter chisel medial 07-09	128.7	7.4	1.19
411.405S	Starter chisel ventral/dorsal 07-09	134.0	13.0	1.19
411.406S	Starter chisel ventral/dorsal 07-09	134.0	13.0	1.19
411.220S	Final chisel lateral 07-09	122.5	7.6	1.19
411.224S	Final chisel medial 07-09	114.5	7.2	1.19
411.413S	Final chisel ventral/dorsal 07-09	118.5	12.0	1.19
411.414S	Final chisel ventral/dorsal 07-09	118.5	12.0	1.19

Ref. (non-sterile)	Article Description
--------------------	---------------------

411.927	Chuck standard 07
----------------	-------------------

400.101	Fixation screw
----------------	----------------

400.106	Allen key
400.111 (with handle)	

GOMINA
SWISS QUALITY

Indicated references by stem size

optimys stem size std. 8

Reference (sterile)	Article Description	L [mm]	W [mm]	T [mm]
411.201S	Prestarter chisel lateral	64.5	4.8	1.19
411.202S	Prestarter chisel medial	64.7	4.3	1.19
411.212S	Starter chisel lateral 07-09	137.5	7.8	1.19
411.216S	Starter chisel medial 07-09	128.7	7.4	1.19
411.405S	Starter chisel ventral/dorsal 07-09	134.0	13.0	1.19
411.406S	Starter chisel ventral/dorsal 07-09	134.0	13.0	1.19
411.220S	Final chisel lateral 07-09	122.5	7.6	1.19
411.224S	Final chisel medial 07-09	114.5	7.2	1.19
411.413S	Final chisel ventral/dorsal 07-09	118.5	12.0	1.19
411.414S	Final chisel ventral/dorsal 07-09	118.5	12.0	1.19

Ref. (non-sterile)	Article Description
--------------------	---------------------

411.928	Chuck standard 08
----------------	-------------------

400.101	Fixation screw
----------------	----------------

400.106	Allen key
400.111 (with handle)	

GOMINA
SWISS QUALITY

Indicated references by stem size

optimys stem size std. 9

Reference (sterile)	Article Description	L [mm]	W [mm]	T [mm]
411.201S	Prestarter chisel lateral	64.5	4.8	1.19
411.202S	Prestarter chisel medial	64.7	4.3	1.19
411.212S	Starter chisel lateral 07-09	137.5	7.8	1.19
411.216S	Starter chisel medial 07-09	128.7	7.4	1.19
411.405S	Starter chisel ventral/dorsal 07-09	134.0	13.0	1.19
411.406S	Starter chisel ventral/dorsal 07-09	134.0	13.0	1.19
411.220S	Final chisel lateral 07-09	122.5	7.6	1.19
411.224S	Final chisel medial 07-09	114.5	7.2	1.19
411.413S	Final chisel ventral/dorsal 07-09	118.5	12.0	1.19
411.414S	Final chisel ventral/dorsal 07-09	118.5	12.0	1.19

Ref. (non-sterile)	Article Description
--------------------	---------------------

411.929	Chuck standard 09
----------------	-------------------

400.101	Fixation screw
----------------	----------------

400.106	Allen key
400.111 (with handle)	

GOMINA
SWISS QUALITY

Indicated references by stem size

optimys stem size std. 10

Reference (sterile)	Article Description	L [mm]	W [mm]	T [mm]
411.201S	Prestarter chisel lateral	64.5	4.8	1.19
411.202S	Prestarter chisel medial	64.7	4.3	1.19
411.213S	Starter chisel lateral 10-12	143.5	9.0	1.19
411.217S	Starter chisel medial 10-12	134.7	8.7	1.19
411.407S	Starter chisel ventral/dorsal 10-12	157.4	16.0	1.19
411.408S	Starter chisel ventral/dorsal 10-12	157.4	16.0	1.19
411.221S	Final chisel lateral 10-12	128.5	8.8	1.19
411.225S	Final chisel medial 10-12	119.5	8.5	1.19
411.415S	Final chisel ventral/dorsal 10-12	118.0	15.0	1.19
411.416S	Final chisel ventral/dorsal 10-12	118.0	15.0	1.19

Ref. (non-sterile)	Article Description
411.930	Chuck standard 10
400.101	Fixation screw
400.106	Allen key
400.111 (with handle)	

GOMINA
SWISS QUALITY

Indicated references by stem size

optimys stem size std. 11

Reference (sterile)	Article Description	L [mm]	W [mm]	T [mm]
411.201S	Prestarter chisel lateral	64.5	4.8	1.19
411.202S	Prestarter chisel medial	64.7	4.3	1.19
411.213S	Starter chisel lateral 10-12	143.5	9.0	1.19
411.217S	Starter chisel medial 10-12	134.7	8.7	1.19
411.407S	Starter chisel ventral/dorsal 10-12	157.4	16.0	1.19
411.408S	Starter chisel ventral/dorsal 10-12	157.4	16.0	1.19
411.221S	Final chisel lateral 10-12	128.5	8.8	1.19
411.225S	Final chisel medial 10-12	119.5	8.5	1.19
411.415S	Final chisel ventral/dorsal 10-12	118.0	15.0	1.19
411.416S	Final chisel ventral/dorsal 10-12	118.0	15.0	1.19

Ref. (non-sterile)	Article Description
--------------------	---------------------

411.931	Chuck standard 11
----------------	-------------------

400.101	Fixation screw
----------------	----------------

400.106	Allen key
400.111 (with handle)	

GOMINA
SWISS QUALITY

Indicated references by stem size

optimys stem size std. 12

Reference (sterile)	Article Description	L [mm]	W [mm]	T [mm]
411.201S	Prestarter chisel lateral	64.5	4.8	1.19
411.202S	Prestarter chisel medial	64.7	4.3	1.19
411.213S	Starter chisel lateral 10-12	143.5	9.0	1.19
411.217S	Starter chisel medial 10-12	134.7	8.7	1.19
411.407S	Starter chisel ventral/dorsal 10-12	157.4	16.0	1.19
411.408S	Starter chisel ventral/dorsal 10-12	157.4	16.0	1.19
411.221S	Final chisel lateral 10-12	128.5	8.8	1.19
411.225S	Final chisel medial 10-12	119.5	8.5	1.19
411.415S	Final chisel ventral/dorsal 10-12	118.0	15.0	1.19
411.416S	Final chisel ventral/dorsal 10-12	118.0	15.0	1.19

Ref. (non-sterile)	Article Description
--------------------	---------------------

411.932	Chuck standard 12
----------------	-------------------

400.101	Fixation screw
----------------	----------------

400.106	Allen key
400.111 (with handle)	



GOMINA
SWISS QUALITY

Overview of all references







optimys stem sizes	Reference	Article Description	L [mm]	W [mm]	T [mm]
All sizes	400.001	Handle incl. extraction bolt			
All sizes	400.100	Extraction bolt (spare part)			
All sizes	411.201S	Prestarter chisel lateral	64.5	4.8	1.19
All sizes	411.202S	Prestarter chisel medial	64.7	4.3	1.19
1/2/3	411.210S	Starter chisel lateral 01-03	129.5	4.8	1.19
4/5/6	411.211S	Starter chisel lateral 04-06	134.5	6.0	1.19
7/8/9	411.212S	Starter chisel lateral 07-09	137.5	7.8	1.19
10/11/12	411.213S	Starter chisel lateral 10-12	143.5	9.0	1.19
1/2/3	411.214S	Starter chisel medial 01-03	116.5	4.3	1.19
4/5/6	411.215S	Starter chisel medial 04-06	123.7	5.6	1.19
7/8/9	411.216S	Starter chisel medial 07-09	128.7	7.4	1.19
10/11/12	411.217S	Starter chisel medial 10-12	134.7	8.7	1.19
1/2/3	411.218S	Final chisel lateral 01-03	110.5	4.6	1.19
4/5/6	411.219S	Final chisel lateral 04-06	116.5	5.8	1.19
7/8/9	411.220S	Final chisel lateral 07-09	122.5	7.6	1.19
10/11/12	411.221S	Final chisel lateral 10-12	128.5	8.8	1.19
1/2/3	411.222S	Final chisel medial 01-03	96.6	4.1	1.19
4/5/6	411.223S	Final chisel medial 04-06	114.5	5.4	1.19
7/8/9	411.224S	Final chisel medial 07-09	114.5	7.2	1.19
10/11/12	411.225S	Final chisel medial 10-12	119.5	8.5	1.19

Overview of all references

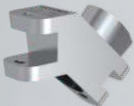
optimys stem sizes	Reference	Article Description	L [mm]	W [mm]	T [mm]
 3	411.401S	Starter chisel ventral/dorsal 01-03	125.9	10.0	1.19
3	411.402S	Starter chisel ventral/dorsal 01-03	125.9	10.0	1.19
4/5/6	411.403S	Starter chisel ventral/dorsal 04-06	130.5	10.0	1.19
4/5/6	411.404S	Starter chisel ventral/dorsal 04-06	130.5	10.0	1.19
7/8/9	411.405S	Starter chisel ventral/dorsal 07-09	134.0	13.0	1.19
7/8/9	411.406S	Starter chisel ventral/dorsal 07-09	134.0	13.0	1.19
10/11/12	411.407S	Starter chisel ventral/dorsal 10-12	157.4	16.0	1.19
10/11/12	411.408S	Starter chisel ventral/dorsal 10-12	157.4	16.0	1.19
 1/2/3	411.409S	Final chisel ventral/dorsal 01-03	118.3	9.0	1.19
1/2/3	411.410S	Final chisel ventral/dorsal 01-03	118.3	9.0	1.19
4/5/6	411.411S	Final chisel ventral/dorsal 04-06	118.4	9.5	1.19
4/5/6	411.412S	Final chisel ventral/dorsal 04-06	118.4	9.5	1.19
7/8/9	411.413S	Final chisel ventral/dorsal 07-09	118.5	12.0	1.19
7/8/9	411.414S	Final chisel ventral/dorsal 07-09	118.5	12.0	1.19
10/11/12	411.415S	Final chisel ventral/dorsal 10-12	118.0	15.0	1.19
10/11/12	411.416S	Final chisel ventral/dorsal 10-12	118.0	15.0	1.19

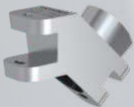
Overview of all references

	optimys stem sizes	Reference	Article Description	L [mm]	W [mm]	T [mm]
	lat. 1	411.901	Chuck lateral 01			
	lat. 2	411.902	Chuck lateral 02			
	lat. 3	411.903	Chuck lateral 03			
	lat. 4	411.904	Chuck lateral 04			
	lat. 5	411.905	Chuck lateral 05			
	lat. 6	411.906	Chuck lateral 06			
	lat. 7	411.907	Chuck lateral 07			
	lat. 8	411.908	Chuck lateral 08			
	lat. 9	411.909	Chuck lateral 09			
	lat. 10	411.910	Chuck lateral 10			
	lat. 11	411.911	Chuck lateral 11			
	lat. 12	411.912	Chuck lateral 12			
	std. 1	411.921	Chuck standard 01			
	std. 2	411.922	Chuck standard 02			
	std. 3	411.923	Chuck standard 03			
	std. 4	411.924	Chuck standard 04			
	std. 5	411.925	Chuck standard 05			
	std. 6	411.926	Chuck standard 06			
	std. 7	411.927	Chuck standard 07			
	std. 8	411.928	Chuck standard 08			
	std. 9	411.929	Chuck standard 09			
	std. 10	411.930	Chuck standard 10			
	std. 11	411.931	Chuck standard 11			
	std. 12	411.932	Chuck standard 12			

Overview of all references

optimys stem sizes	Reference	Article Description	L [mm]	W [mm]	T [mm]
 All sizes	400.101	Fixation screw			
 All sizes	400.106	Allen key			
	400.111(with handle)				

Overview of ventral & dorsal chisels

Reference	Article description	Right hip		Left hip	
		ventral	dorsal	ventral	dorsal
411.401S	Starter chisel ventral / dorsal 01-03	✓	-	-	✓
411.402S	Starter chisel ventral / dorsal 01-03	-	✓	✓	-
411.403S	Starter chisel ventral / dorsal 04-06	✓	-	-	✓
411.404S	Starter chisel ventral / dorsal 04-06	-	✓	✓	-
411.405S	Starter chisel ventral / dorsal 07-09	✓	-	-	✓
411.406S	Starter chisel ventral / dorsal 07-09	-	✓	✓	-
411.407S	Starter chisel ventral / dorsal 10-12	✓	-	-	✓
411.408S	Starter chisel ventral / dorsal 10-12	-	✓	✓	-
411.409S	Final chisel ventral / dorsal 01-03	✓	-	-	✓
411.410S	Final chisel ventral / dorsal 01-03	-	✓	✓	-
411.411S	Final chisel ventral / dorsal 04-06	✓	-	-	✓
411.412S	Final chisel ventral / dorsal 04-06	-	✓	✓	-
411.413S	Final chisel ventral / dorsal 07-09	✓	-	-	✓
411.414S	Final chisel ventral / dorsal 07-09	-	✓	✓	-
411.415S	Final chisel ventral / dorsal 10-12	✓	-	-	✓
411.416S	Final chisel ventral / dorsal 10-12	-	✓	✓	-

Contact



Gomina AG
Raiftstrasse 4
3989 Niederwald, Switzerland
Phone +41 27 970 12 70
Fax +41 27 970 12 75
www.gomina.ch
sales@gomina.ch

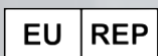

GOMINA Deutschland GmbH
Ludwig-Vierling-Strasse 7
89233 Neu-Ulm, Germany
info@gomina.de

Version 2026-03
Last modification: 11.03.2026